

Hardware User Manual

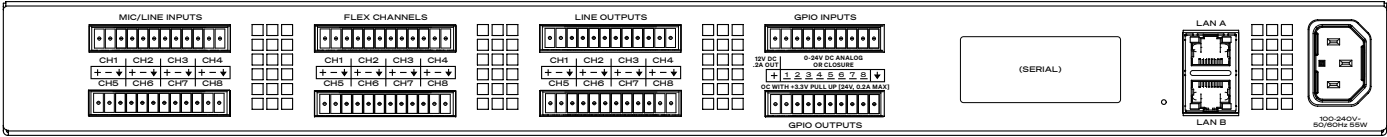

Q-SYS QIO High Density Series:

QIO-24f, QIO-ML24i, QIO-L24o

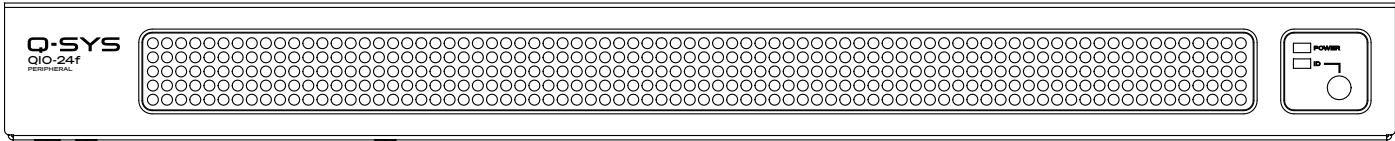

(QIO-24f shown)



EXPLANATION OF TERMS AND SYMBOLS

The term "**WARNING!**" indicates instructions regarding personal safety. If the instructions are not followed the result may be bodily injury or death.

The term "**CAUTION!**" indicates instructions regarding possible damage to physical equipment. If these instructions are not followed, it may result in damage to the equipment that may not be covered under the warranty.

The term "**IMPORTANT!**" indicates instructions or information that are vital to the successful completion of the procedure.

The term "**NOTE**" is used to indicate additional useful information.



The lightning flash with arrowhead symbol in a triangle alerts the user to the presence of uninsulated dangerous voltage within the product's enclosure that may constitute a risk of electric shock to humans.



The exclamation point within a triangle alerts the user to the presence of important safety, operating, and maintenance instructions in this manual.



IMPORTANT SAFETY INSTRUCTIONS



WARNING! TO PREVENT FIRE OR ELECTRIC SHOCK, DO NOT EXPOSE THIS EQUIPMENT TO RAIN OR MOISTURE.

Elevated Operating Ambient – If installed in a closed or multi-unit rack assembly, the ambient operating temperature of the rack environment may be greater than room ambient. Ensure that the maximum allowed operating temperature is not exceeded – see the "Environmental Specifications" section.

Reduced Air Flow – Installation of the equipment in a rack should be such that the amount of air flow required for safe operation of the equipment is not compromised.

1. Read, follow, and keep these instructions.
2. Heed all warnings.
3. Do not use this apparatus near water.
4. Do not submerge the apparatus in water or liquids.
5. Do not use any aerosol spray, cleaner, disinfectant or fumigant on, near or into the apparatus.
6. Clean only with a dry cloth.
7. Do not block any ventilation opening. Installation next to another unit within a rack should allow enough air flow required for safe operation.
8. Keep the side ventilation openings free of dust or other matter.
9. Do not install near any heat sources such as radiators, heat registers, stoves, or other apparatus (including amplifiers) that produce heat.
10. To reduce the risk of electrical shock, the power cord shall be connected to a mains socket outlet with a protective earthing connection.
11. Do not defeat the safety purpose of the grounding-type plug. A grounding type plug has three prongs, one of which is the grounding prong. The plugs are designed to fit only one way into the socket. The grounding prong is provided for your safety. If the provided plug does not fit into your outlet, obtain a power cord that is properly configured, or consult an electrician for replacement of the obsolete outlet.

NOTE: The type of grounding plug depends on the country.

12. Protect the power cord from being walked on or pinched, particularly at plugs, convenience receptacles, and the point where they exit from the apparatus.
13. Do not unplug the unit by pulling on the cord; use the plug.

14. Only use attachments/accessories specified by the manufacturer.
15. Unplug the apparatus during lightning storms or when unused for long periods of time.
16. Refer all servicing to qualified service personnel. Servicing is required when the apparatus has been damaged in any way, such as when the power supply cord or plug is damaged, liquid has been spilled or objects have fallen into the apparatus, the apparatus has been exposed to rain or moisture, does not operate normally, or has been dropped.
17. The appliance coupler, or the AC Mains plug, is the AC mains disconnect device and shall remain readily accessible after installation.
18. Adhere to all applicable, local codes.
19. Consult a licensed, professional engineer when any doubt or questions arise regarding a physical equipment installation.

Maintenance and Repair



WARNING!: Advanced technology, e.g., the use of modern materials and powerful electronics, requires specially adapted maintenance and repair methods. To avoid a danger of subsequent damage to the apparatus, injuries to persons and/or the creation of additional safety hazards, all maintenance or repair work on the apparatus should be performed only by a Q-SYS authorized service station or an authorized Q-SYS International Distributor. QSC is not responsible for any injury, harm or related damages arising from any failure of the customer, owner or user of the apparatus to facilitate those repairs.

Environmental Specifications

- **Expected Product Life Cycle:** 10 years
- **Storage Temperature Range:** -20°C to +70°C
- **Storage Humidity Range:** 5% to 85% RH, non-condensing
- **Operating Temperature Range:** 0°C to +50°C
- **Operating Humidity Range:** 5% to 85% RH, non-condensing, with a maximum heat index of +50°C. At 85% RH, the maximum operating ambient air temperature is 32.8°C. Conversely, operating RH levels shall be de-rated in the presence of higher operating temperatures (above 33°C).

Environmental Compliance

QSC complies with all applicable environmental regulations. This includes (but is not limited to) global environmental laws, such as EU WEEE Directive (2012/19/EU), China RoHS, Korean RoHS, European RoHS, U.S. Federal and State Environmental Laws, and various resource recycling promotion laws around the world. For more information, visit:

qsys.com/about-us/green-statement

FCC Statement



This equipment has been tested and found to comply with the limits for a Class A digital device, pursuant to Part 15 of the FCC Rules. Operation is subject to the following two conditions:

1. This device may not cause harmful interference.
2. This device must accept any interference received, including interference that may cause undesired operation.

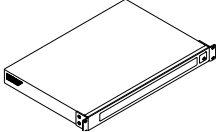
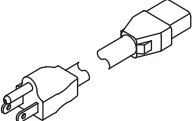
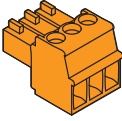
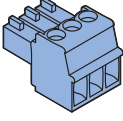
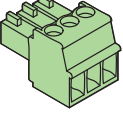
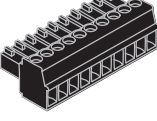

These limits are designed to provide reasonable protection against harmful interference when the equipment is operated in a commercial environment. This equipment generates, uses, and can radiate radio frequency energy and, if not installed and used in accordance with the instruction manual, may cause harmful interference to radio communications. Operation of this equipment in a residential area is likely to cause harmful interference in which case the user will be required to correct the interference at his own expense.

What's in the Box

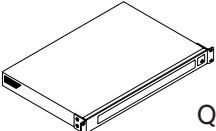
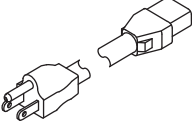
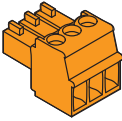
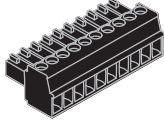

QIO-24f

 <p>x1 QIO-24f</p>	 <p>x1 AC Power Cord</p>	 <p>x8 Mic/Line In (orange)</p>	 <p>x8 Flex Channels (blue)</p>
 <p>x8 Line Out (green)</p>	 <p>x2 GPIO (black)</p>	 <p>x1 Safety and Regulatory Statements TD-001723</p>	 <p>x1 Warranty TD-000453</p>

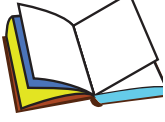
QIO-ML24i

 <p>x1 QIO-ML24i</p>	 <p>x1 AC Power Cord</p>	 <p>x24 Mic/Line In (orange)</p>	 <p>x2 GPIO (black)</p>
 <p>x1 Safety and Regulatory Statements TD-001723</p>	 <p>x1 Warranty TD-000453</p>		

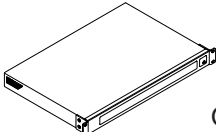
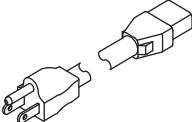
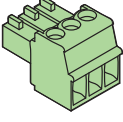
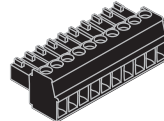
QIO-L24o

 <p>x1 QIO-L24o</p>	 <p>x1 AC Power Cord</p>	 <p>x24 Line Out (green)</p>	 <p>x2 GPIO (black)</p>
 <p>x1 Safety and Regulatory Statements TD-001723</p>	 <p>x1 Warranty TD-000453</p>		

Introduction

The **Q-SYS QIO-24f** is a network audio endpoint native to the Q-SYS Ecosystem, serving as a set of audio inputs and outputs that enables network-based audio distribution. The form factor of this product facilitates a high density of 24 analog audio connections in a standard 1U rack space, ideal for applications that require a large number of audio connections. The QIO-24f offers eight mic/line input connections, eight FLEX I/O connections that can be used as inputs or outputs, and eight line output connections; along with 8×8 GPIO ports for control. Dual Ethernet connectors provide optional network redundancy, and two of these products can also be installed in a redundant failover pair to guard against unexpected audio interruptions in critical applications.

The **Q-SYS QIO-ML24i** is a network audio endpoint native to the Q-SYS Ecosystem, serving as a set of mic/line inputs that enables network-based audio distribution. The form factor of this product facilitates a high density of 24 analog audio connections in a standard 1U rack space, ideal for applications that require a large number of audio connections. The QIO-ML24i offers 24 mic/line input connections along with 8×8 GPIO ports for control. Dual Ethernet connectors provide optional network redundancy, and two of these products can also be installed in a redundant failover pair to guard against unexpected audio interruptions in critical applications.

The **Q-SYS QIO-L24o** is a network audio endpoint native to the Q-SYS Ecosystem, serving as a set of line outputs that enables network-based audio distribution. The form factor of this product facilitates a high density of 24 analog audio connections in a standard 1U rack space, ideal for applications that require a large number of audio connections. The QIO-L24o offers 24 line output connections along with 8×8 GPIO ports for control. Dual Ethernet connectors provide optional network redundancy, and two of these products can also be installed in a redundant failover pair to guard against unexpected audio interruptions in critical applications.



NOTE: Q-SYS QIO High Density Series devices require Q-SYS Designer Software (QDS) for configuration and operation. QDS version compatibility information can be found [here](#). Information about the QDS components related to these devices, including their properties and controls, can be found in Q-SYS Help at help.qsys.com. Or, simply drag a QIO device component from the Inventory into the Schematic and press F1.

Connections and Callouts

Front Panel - All Models

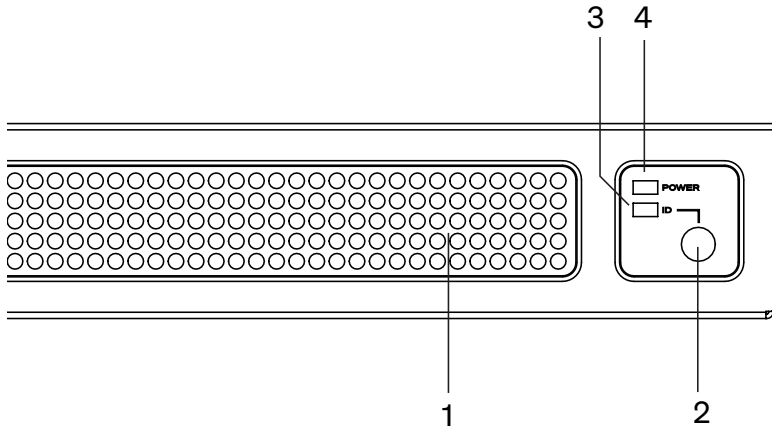

1. Air intake vents
2. ID button invokes ID feature
3. ID LED illuminates when ID feature is invoked
4. POWER on LED

Rear Panel - Right Side - All Models

(QIO-24f shown)

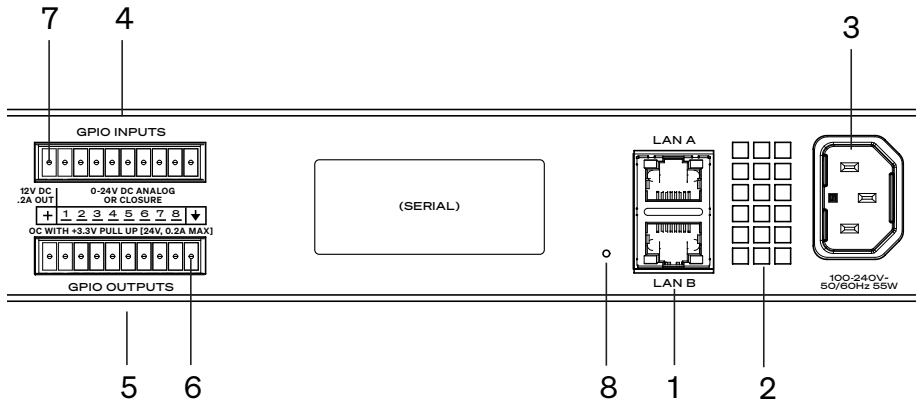

1. LAN ports (dual) - Up to 1 Gbps per port
2. Exhaust vents (do not block)
3. AC mains inlet connector - Supports universal (international) mains
4. General Purpose Inputs (8 pins, 2-9) 0-24VDC analog, potentiometer, TTL digital or contact closure input.
5. General Purpose Outputs (8 pins, 2-9) Open collector (24V, 0.2A max), with pullups to 3.3V or TTL output
6. Ground Reference (Pin 10 on each connector)
7. 12VDC Source (Pin 1 on each connector). Provides up to 0.2A per pin
8. Device Reset - Use a paperclip or similar tool to restore default network settings and recover factory default settings. Before attempting a reset, refer to support.qsys.com for details.

Rear Panel - Left Side - QIO-24f

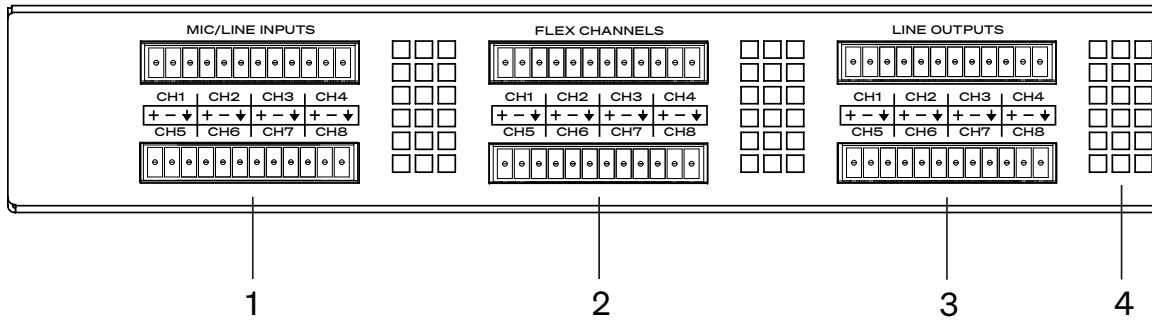

1. Mic/Line Inputs (8 channels - orange) - Balanced or Unbalanced plus +48V (P48) phantom power compliant with IEC 61938
2. Flex Channels (8 channels - blue) - Configurable as Mic/Line Input or Line Output per channel
3. Line Outputs (8 channels - green) - Balanced or Unbalanced
4. Exhaust vents (do not block)

Rear Panel - Left Side - QIO-ML24i

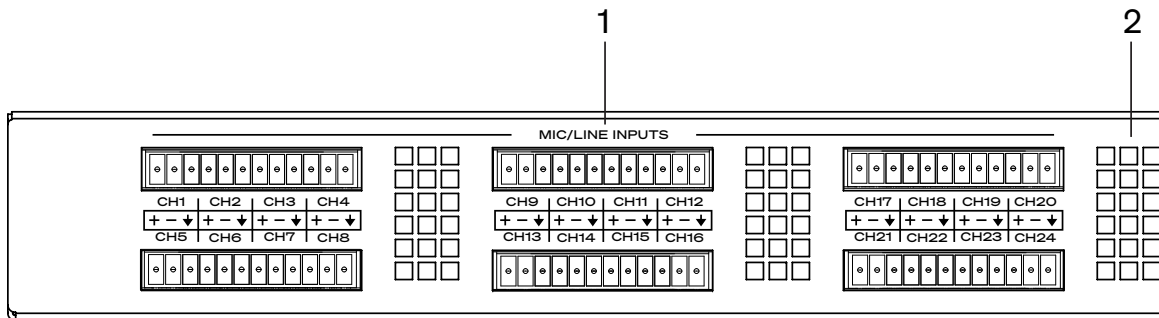

1. Mic/Line Inputs (24 channels - orange) - Balanced or Unbalanced plus +48V (P48) phantom power compliant with IEC 61938
2. Exhaust vents (do not block)

Rear Panel - Left Side - QIO-L24o

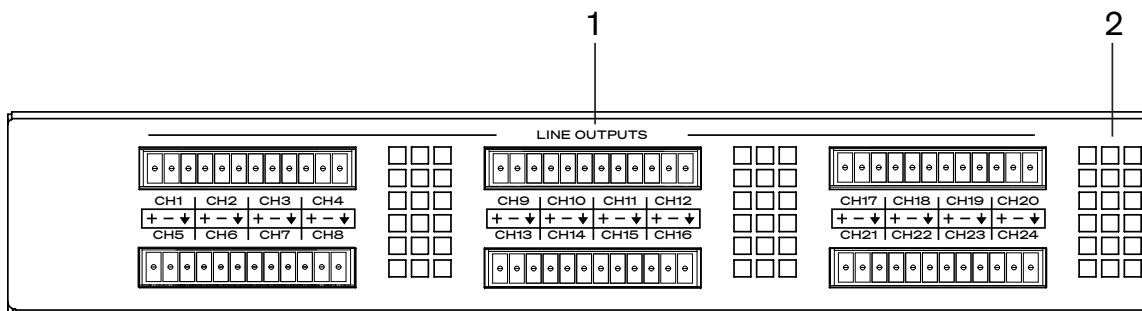

1. Line Outputs (24 channels - green) - Balanced or Unbalanced
2. Exhaust vents (do not block)

Connections

This figure illustrates the various audio connections on QIO High Density Series devices, as applicable. GPIO connections are similar. 3-terminal connector plugs are provided for all audio I/O. 10-terminal connector plugs are provided for GPI and GPO connections.

3-Pin, color-coded, audio Euro connectors:

- Mic/Line Inputs (orange)
- Flex Channels (blue)
- Line Outputs (green)

Note:

- When constructing audio cables, follow the connection wiring as shown.
- All LAN ports require CAT-5e data communications cables.

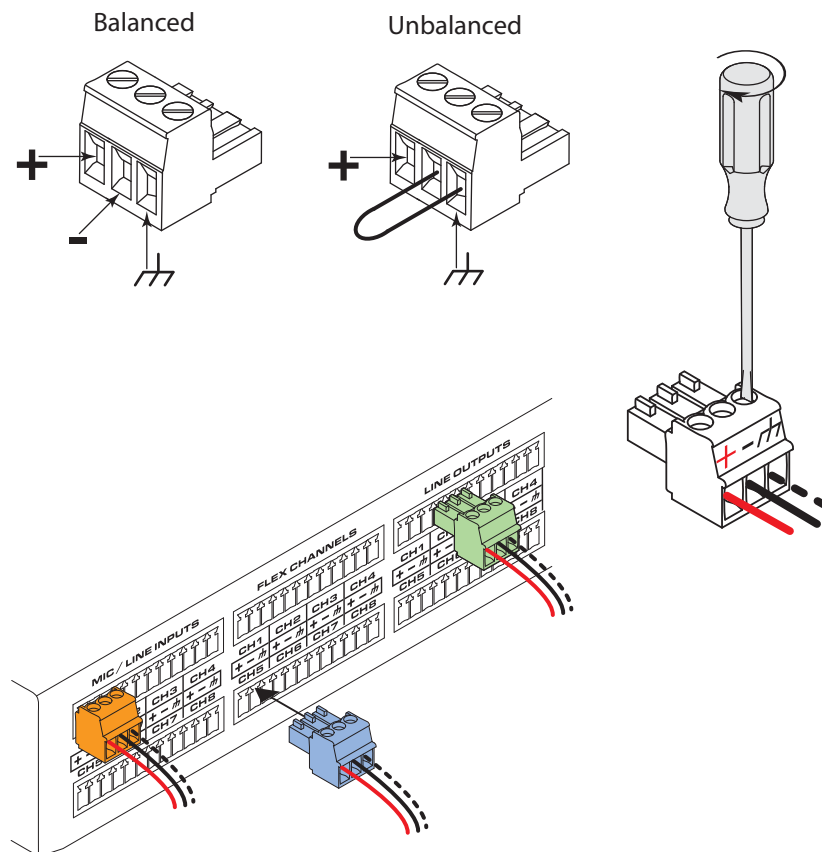

CAUTION! A single audio channel consists of three pins. It is possible to plug in a connector that straddles two channels. Be sure that the plugs do not straddle two channels.

Optional: Wiring for Redundancy

Use the optional QIO-CK redundancy cable kit to connect all audio channels of a QIO High Density Series device to another device of the same model. When a failover condition occurs, the entire device (all channels) fails over to the backup. For more information about Q-SYS redundancy, including failover information, see the [Q-SYS Help](#).

The QIO-CK kit comes with six (6) cables, each for Euro-style connection to four channels of either the Mic/Line Inputs, Flex Channels, or Line Outputs, depending on the model. Each channel is pre-wired between a Primary and Backup connector with Audio + (red), Audio - (black), and Ground (green) wires to make the redundant connection. The Primary connector features spring-loaded, push-style connections for input or output audio devices.

NOTE: Only identical peripheral models can be a redundant pair. For example, you can't join a QIO-24f and a QIO-ML24i into a redundant pair.

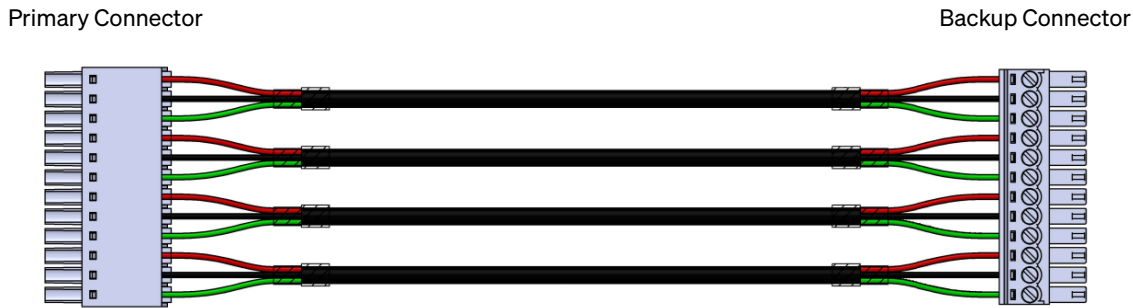

To wire a QIO High Density device for redundancy:

1. Ensure that the Primary and Backup devices are vertically adjacent to each other in the rack, and are the same QIO High Density Series model.
2. Connect the Primary Connector (larger connector) to one of the 4-channel audio blocks on the Primary device.
3. Connect the Backup Connector (smaller connector) to the matching 4-channel audio block on the Backup device.
4. Connect audio device input or output wires to the top row of the Primary Connector using the spring-loaded, push-style connectors. **Note:** To release wires, use a small screwdriver to push in the wire release buttons.
5. Repeat steps 2-4 for the remaining five redundant cables and 4-channel blocks.

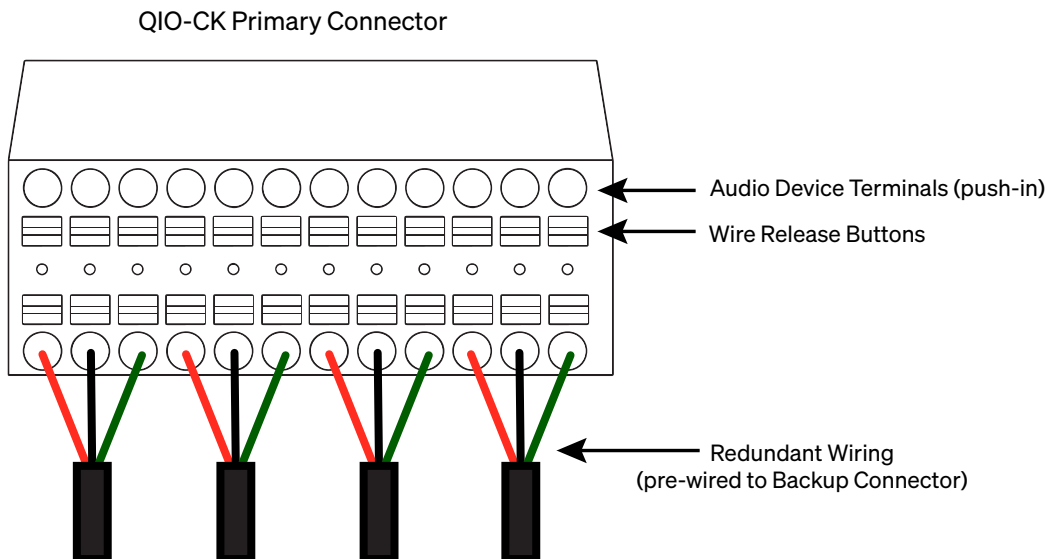

Installation

Q-SYS QIO High Density devices come with rack ears pre-installed. These ears can be removed for desktop or credenza mounting.

The forward rack ear positions support installation of the device into a standard IEC 60297 compliant equipment rack occupying one vertical rack unit (1-3/4").



WARNING!: Proper ventilation is required! A minimum of six inches of open space (free of objects) must be maintained behind the Q-SYS QIO High Density device as measured from the rear panel. A minimum of one half inch of open space must be maintained on each side of the device in the rack. It is recommended that a minimum of one half RU space be maintained above and below the device to avoid thermal coupling with adjacent equipment. Avoid installing a Q-SYS QIO High Density device directly on top of or below a power amplifier or other heat generating appliance. A fresh supply of moving air must be provided at the front and rear of a Q-SYS QIO High Density device in all installation types.

The supplied rack ears can be removed from the front of the chassis and relocated to the middle of the chassis to accommodate surface mounting to the top or bottom of a table, shelf or other structure. The table, shelf or structure must be a cool surface. Avoid installing the device on top of or below a structure that generates heat and where ventilation is inadequate. Note that the device must remain in a horizontal position! Wall mounting or any other mounting configuration where a Q-SYS QIO High Density device would be in a vertical orientation is not supported. See figures.

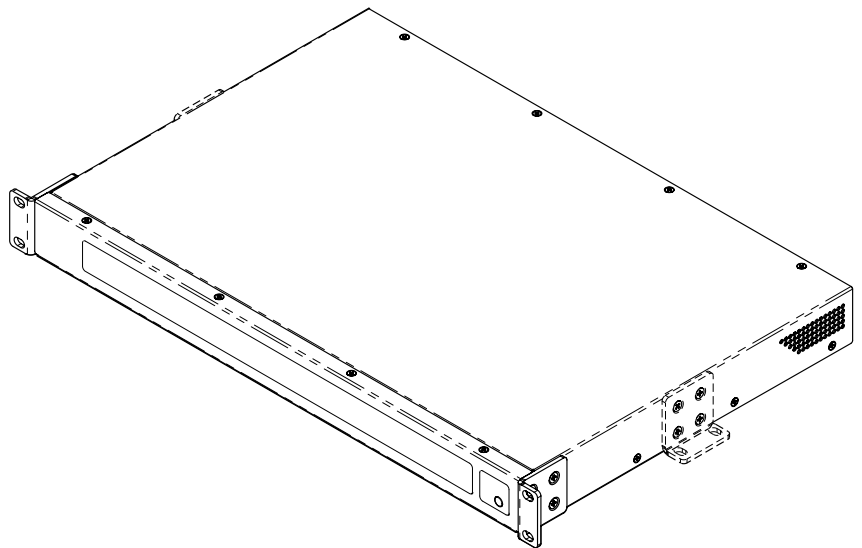
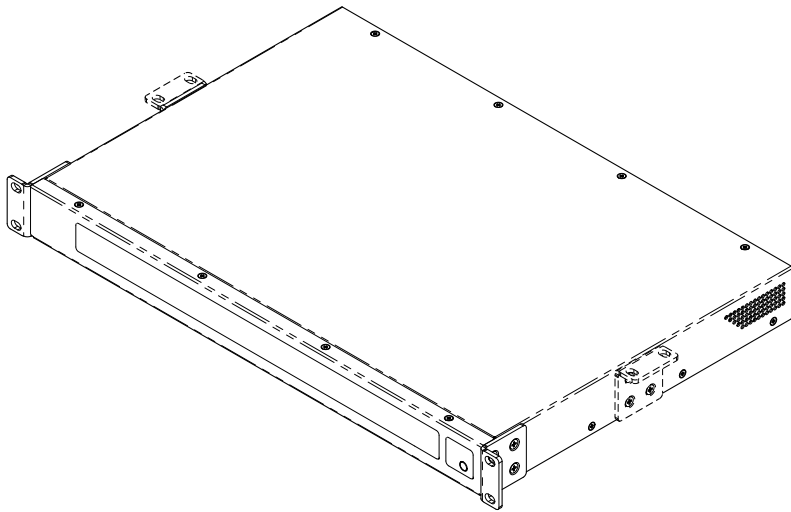



Knowledge Base

Find answers to common questions, troubleshooting information, tips, and application notes. Link to support policies and resources, including Q-SYS Help, software and firmware, product documents, and training videos. Create support cases.

support.qsys.com

Customer Support

Refer to the Contact Us page on the Q-SYS website for Technical Support and Customer Care, including their phone numbers and hours of operation.

qsys.com/contact-us/

Warranty

For a copy of the QSC Limited Warranty, go to:

qsys.com/support/warranty-statement/

Manufacturer Information

QSC, LLC
1675 MacArthur Blvd., Costa Mesa, CA 92626, USA

EU Representative:

QSC EMEA GmbH
Am Ilvesbach 6, 74889 Sinsheim, Germany
+49 7261 6595 300
info.emea@qsc.com

<https://www.qsc.com>