

Hardware User Guide

Digital Cinema I/O — DCIO-H

Digital Cinema I/O — DCIO

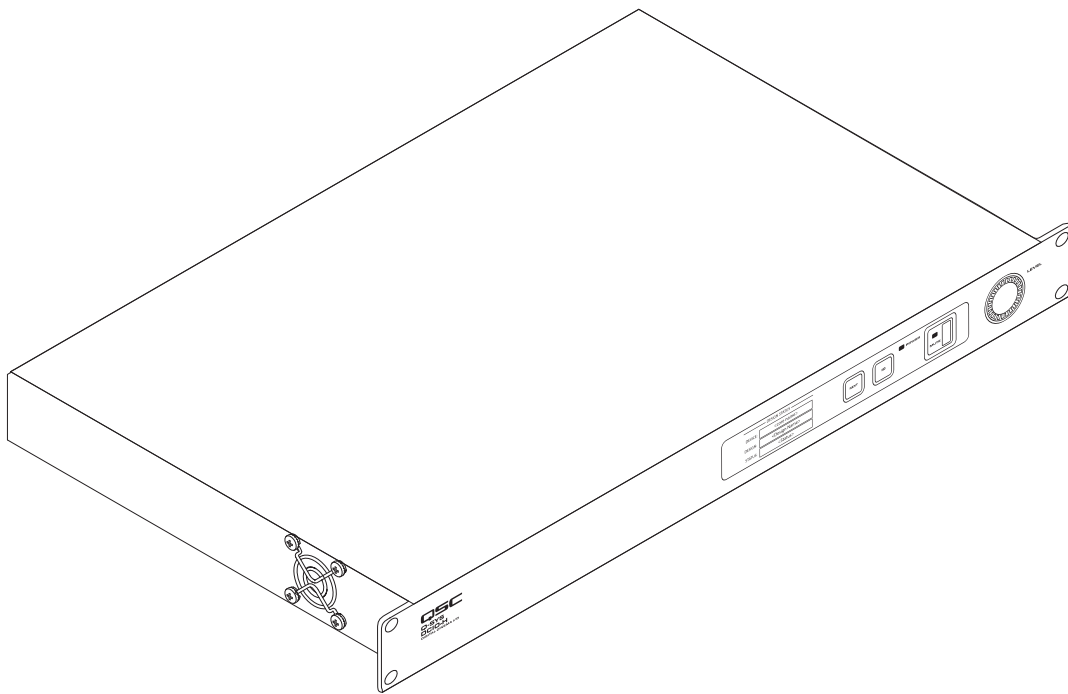

TD-001532-01-A



EXPLANATION OF TERMS AND SYMBOLS

The term "WARNING!" indicates instructions regarding personal safety. If the instructions are not followed the result may be bodily injury or death.

The term "CAUTION!" indicates instructions regarding possible damage to physical equipment. If these instructions are not followed, it may result in damage to the equipment that may not be covered under the warranty.

The term "IMPORTANT!" indicates instructions or information that are vital to the successful completion of the procedure.

The term "NOTE" is used to indicate additional useful information.



The intent of the lightning flash with arrowhead symbol in a triangle is to alert the user to the presence of un-insulated "dangerous" voltage within the product's enclosure that may be of sufficient magnitude to constitute a risk of electric shock to humans.



The intent of the exclamation point within an equilateral triangle is to alert the user to the presence of important safety, and operating and maintenance instructions in this manual.



IMPORTANT SAFETY INSTRUCTIONS



WARNING!: TO PREVENT FIRE OR ELECTRIC SHOCK, DO NOT EXPOSE THIS EQUIPMENT TO RAIN OR MOISTURE.

- **Elevated Operating Ambient** - If installed in a closed or multi-unit rack assembly, the ambient operating temperature of the rack environment may be greater than room ambient. Consideration should be given to ensure that the maximum operating temperature range (0°C to 50°C (32°F to 122°F)) is not exceeded.
- **Reduced Air Flow** – Installation of the equipment in a rack should be such that the amount of air flow required for safe operation of the equipment is not compromised.

1. Read these instructions.
2. Keep these instructions.
3. Heed all warnings.
4. Follow all instructions.
5. Do not use this apparatus near water.
6. Do not submerge the apparatus in water or liquids.
7. Do not use any aerosol spray, cleaner, disinfectant or fumigant on, near or into the apparatus.
8. Clean only with a dry cloth.
9. Do not block any ventilation opening. Install in accordance with the manufacturer's instructions.
10. Keep all ventilation openings free of dust or other matter.
11. Do not install near any heat sources such as radiators, heat registers, stoves, or other apparatus (including amplifiers) that produce heat.
12. To reduce the risk of electrical shock, the power cord shall be connected to a mains socket outlet with a protective earthing connection.
13. Do not defeat the safety purpose of the polarized or grounding-type plug. A polarized plug has two blades with one wider than the other. A grounding type plug has two blades and a third grounding prong. The wide blade or the third prong are provided for your safety. If the provided plug does not fit into your outlet, consult an electrician for replacement of the obsolete outlet.
14. Protect the power cord from being walked on or pinched particularly at plugs, convenience receptacles, and the point where they exit from the apparatus.
15. Do not unplug the unit by pulling on the cord, use the plug.
16. Only use attachments/accessories specified by the manufacturer.
17. Unplug this apparatus during lightning storms or when unused for long periods of time.
18. Refer all servicing to qualified service personnel. Servicing is required when the apparatus has been damaged in any way, such as power-supply cord or plug is damaged, liquid has been spilled or objects have fallen into the apparatus, the apparatus has been exposed to rain or moisture, does not operate normally, or has been dropped.
19. The appliance coupler, or the AC Mains plug, is the AC mains disconnect device and shall remain readily accessible after installation.
20. Adhere to all applicable, local codes.
21. Consult a licensed, professional engineer when any doubt or questions arise regarding a physical equipment installation.

Maintenance and Repair



WARNING!: Advanced technology, e.g., the use of modern materials and powerful electronics, requires specially adapted maintenance and repair methods. To avoid a danger of subsequent damage to the apparatus, injuries to persons and/or the creation of additional safety hazards, all maintenance or repair work on the apparatus should be performed only by a QSC authorized service station or an authorized QSC International Distributor. QSC is not responsible for any injury, harm or related damages arising from any failure of the customer, owner or user of the apparatus to facilitate those repairs.

FCC Statement

This equipment has been tested and found to comply with the limits for a Class A digital device, pursuant to Part 15 of the FCC Rules. These limits are designed to provide reasonable protection against harmful interference when the equipment is operated in a commercial environment. This equipment generates, uses, and can radiate radio frequency energy and, if not installed and used in accordance with the instruction manual, may cause harmful interference to radio communications. Operation of this equipment in a residential area is likely to cause harmful interference in which case the user will be required to correct the interference at his own expense.



IMPORTANT!: The Q-SYS DCIO may operate at elevated temperatures and therefore its exterior may become noticeably warm. This is normal. The Q-SYS DCIO is designed with convection cooling in mind and therefore incorporates industrial high-temp components to accommodate higher operating temperatures.

Expected Product Life Cycle: 20 years, **Storage Temperature range:** -20°C to + 70°C, **Relative Humidity range:** of 5 – 85% RH non-condensing.

RoHS STATEMENT

The QSC Q-SYS DCIO is in compliance with European Directive 2011/65/EU – Restriction of Hazardous Substances (RoHS2).

The QSC Q-SYS DCIO is in compliance with “China RoHS” directives. The following chart is provided for product use in China and its territories:

		QSC Q-SYS DCIO				
部件名称 (Part Name)	有害物质 (Hazardous Substances)					
	铅 (Pb)	汞 (Hg)	镉 (Cd)	六价铬 (Cr(vi))	多溴联苯 (PBB)	多溴二苯醚 (PBDE)
电路板组件 (PCB Assemblies)	X	O	O	O	O	O
机壳装配件 (Chassis Assemblies)	X	O	O	O	O	O

本表格依据 SJ/T 11364 的规定编制。

O: 表示该有害物质在该部件所有均质材料中的含量均在 GB/T 26572 规定的限量要求以下。

X: 表示该有害物质至少在该部件的某一均质材料中的含量超出 GB/T 26572 规定的限量要求。(目前由于技术或经济的原因暂时无法实现替代或减量化。)

This table is prepared following the requirement of SJ/T 11364.

O: Indicates that the concentration of the substance in all homogeneous materials of the part is below the relevant threshold specified in GB/T 26572.

X: Indicates that the concentration of the substance in at least one of all homogeneous materials of the part is above the relevant threshold specified in GB/T 26572.

(Replacement and reduction of content cannot be achieved currently because of the technical or economic reason.)

Warranty

For a copy of the QSC Limited Warranty, visit the QSC, LLC. website at www.qsc.com

Para una copia de la Garantía Limitada de QSC, visite el sitio web de QSC, LLC., en www.qsc.com Pour obtenir une copie de la garantie limitée de QSC, visitez le site de QSC, LLC. à www.qsc.com

Besuchen Sie die Webseite von QSC, LLC. (www.qsc.com) um eine Kopie der beschränkten Garantie von QSC zu erhalten.



如果您想要QSC有限保修的複印本, 請造訪QSC音頻產品的網站www.qsc.com

Для получения копии ограниченной гарантии QSC посетите веб-сайт QSC, LLC., расположенный по адресу www.qsc.com.

ةتوصل اتاجت نملل QSC ةكرشل ينورت لكل!! ع قوملا ةراي زب مق .QSC ب صاخلا دودح ملام نامضلا نم ةخسن ىلع لوصحلل
www.qsc.com ىلع

QSC限定保証の複製には、QCSのウェブサイトwww.qsc.comにアクセスしてください。

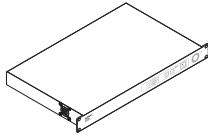
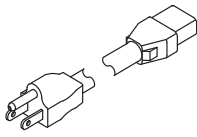
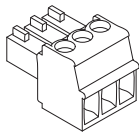
Package Contents

	1 DCIO		1 AC Power cord		1 Euro-style Connector plug kit (4 connectors)
	1 DCIO Installation TD-0015xx		1 QSC Warranty TD-000453		

About the DCIO / DCIO-H

QSC's DCIO and DCIO-H are Q-SYS peripherals and require connection to a Q-SYS Core via Q-LAN in order to operate. When the connection is made, you must create a design in Q-SYS Designer and include the DCIO or DCIO-H in that design. Refer to the Q-SYS Designer online Help system for complete information.

Installation – Rack-Mounting



CAUTION!: Be sure that each side has a minimum of 2 cm clearance.

The DCIO is designed to be mounted in a standard 19" (480 mm) equipment rack and requires 1 vertical rack space.

Secure the DCIO in the rack with four screws in front (screws not included).

Features

Front Panel

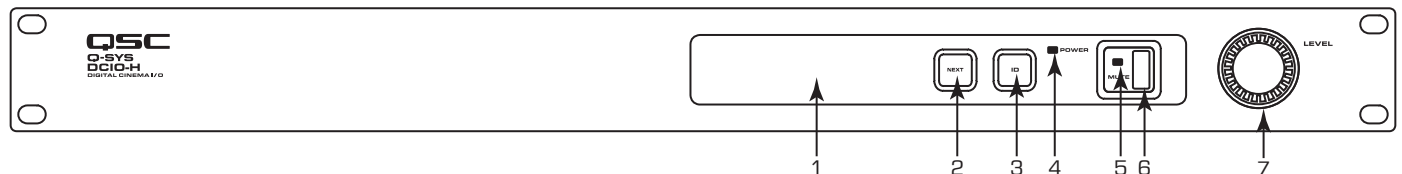

— Figure 1 —





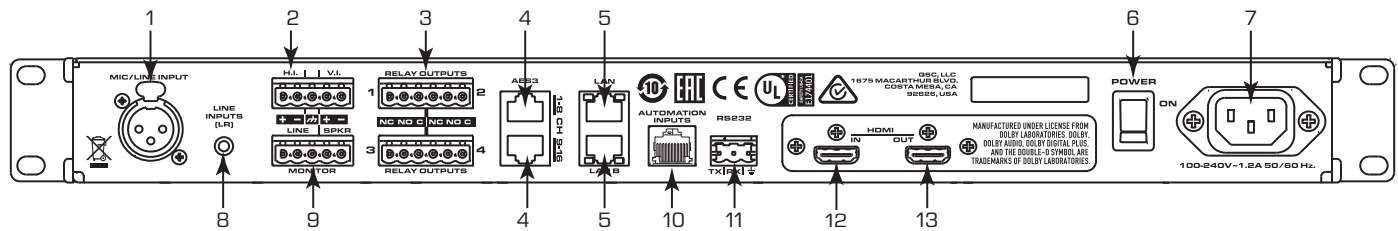

- OLED** display – Displays information about the DCIO's settings and status.
- NEXT** button – Cycles through the OLED information pages.
- ID** button – Locates the DCIO in Q-SYS Designer GUI and Configurator.
- POWER** LED – Illuminates blue when the DCIO is on.
- MUTE** LED – Illuminates red when the DCIO master mute is engaged.
- MUTE** button – Enables/Disables master mute.
- LEVEL** rotary – Adjusts the master level.

Rear Panel

All inputs and outputs are configured in Q-SYS Designer software running on the Q-SYS Core to which the DCIO is connected.

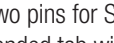

— Figure 2 —

1. **MIC / LINE INPUT** – Standard three-conductor XLR connector, balanced input, phantom power available in Q-SYS Designer. Used for: mono, non-sync sources including microphone for in-auditorium announcements, and SPL metering. Refer to — Figure 3 for wiring.
2. **Hearing Impaired and Visually Impaired Outputs (H.I. and V.I.)** – Five-terminal Euro-style receptacle, balanced outputs, used for: hearing- and / or visually-impaired special mixes. The receptacle label provides a pin-out  of the signals. The ground is common to both. Refer to — Figure 4 for wiring.
 -  **TIP:** A standard three-terminal Euro-style connector may be used if only one output is required. Make sure the plug is all the way to the right, or all the way to the left of the five-terminal receptacle.
3. **RELAY OUTPUTS** – Two six-terminal Euro-style receptacles, mechanically de-coupled control outputs, floating relay contacts, rated for 30 VDC at 1A. Each relay output has one common contact (C), one normally open contact (NO) and one normally closed (NC) contact. When not energized, C is connected to NC and NO is not connected. When energized, C is connected to NO and NC is not connected. Used for controlling curtains, lighting, etc.) Refer to — Figure 5 for wiring.
4. **AES3 INPUTS** – RJ45, CAT-5 or better to connect to sources using the same type connector and pinout.
 - AES3 1–8** – AES3 pairs 1 through 4 (digital audio channels 1–8)
 - AES3 9–16** – AES3 pairs 5 through 8 (digital audio channels 9–16)
 Used for primary content audio from the server or media block. Refer to — Table 1 and — Table 2 for pin-out.
 -  **NOTE:** The AES3 connectors are NOT network connections.
5. **LAN connections** – RJ45, CAT-5E or better.
 - LAN A** – Used for primary Q-LAN connection, required.
 - LAN B** – Used for redundancy.
6. **POWER ON / OFF switch**
7. **IEC CONNECTOR** – AC mains power connector
8. **Line Inputs (LR)** – Standard 3.5mm TRS jack, unbalanced, stereo, analog, line-input. Used for non-sync sources appropriate for alternative content, advertising, corporate or live event feeds.
9. **MONITOR OUTPUTS** – Five-pin, Euro-style connector; three-pins for Line  and two pins for Speaker . The supplied connectors have an extended tab with holes for securing the wiring to the connector. Refer to — Figure 6 and the pin-out label on the rear panel for wiring.
 - a. **LINE** – The Line output provides a balanced output at 14 dBu, via three pins of the Euro-style connector.
 - b. **SPEAKER** – Powered output, 10 watts maximum, via two pins of the Euro-style connector.
 -  **TIP:** A standard two- or three-terminal plug may be used if only one output is required.
10. **AUTOMATION INPUTS** – RJ45, contact closures. The Automation Inputs can be connected to relay contacts or a switch (control presets, mute etc). Refer to — Table 3 for the connector pin-out.
11. **RS-232 Serial Communications** – Three-pin Euro-style connector for (Rx), transmit (Tx) and ground pin. Used for third-party control or automation. Refer to — Figure 7 for wiring.
12. **HDMI In** – DCIO-H  model only. Extracts audio from incoming HDMI stream and passes the stream directly to output HDMI port for connection to a downstream video device. Up to 8 channels of PCM audio are supported. Additionally, Dolby Digital Plus™ and DTS-HD® decoders will be automatically applied if those bitstreams are detected.
13. **HDMI Out** – DCIO-H model only. See HDMI In.

Connector Wiring

Mic/Line Input wiring

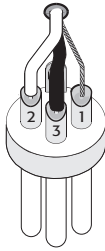
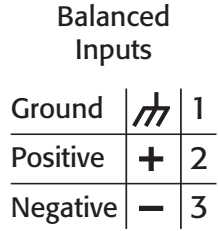

— Figure 3 —

H.I. and V.I. wiring

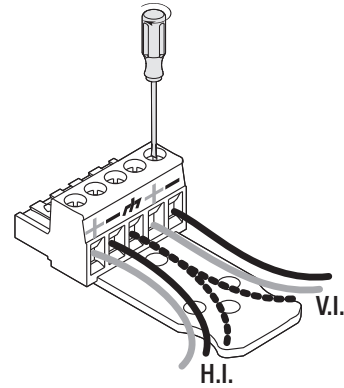

— Figure 4 —

Relay wiring

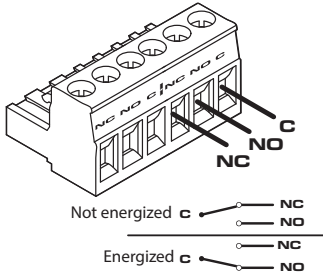

— Figure 5 —

MONITOR wiring

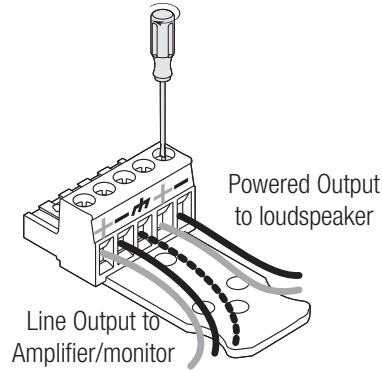

— Figure 6 —

RS-232 wiring

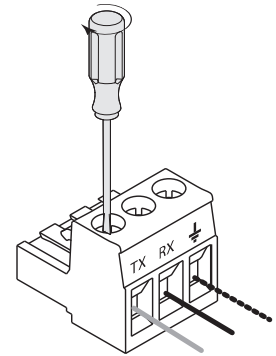

— Figure 7 —

— Table 1 —

AES3 INPUTS 1-8		
Pin #	Description	Channel
1	AES Pair 1: +	L, R
2	AES Pair 1: -	
3	AES Pair 2: +	C, Sub
4	AES Pair 3: -	LS, RS
5	AES Pair 3: +	
6	AES Pair 2: -	C, Sub
7	AES Pair 4: +	BL, BR
8	AES Pair 4: -	

— Table 2 —

AES3 INPUTS 9-16		
Pin #	Description	Channel
1	AES Pair 1: +	CH 9-10
2	AES Pair 1: -	
3	AES Pair 2: +	CH 11-12
4	AES Pair 3: -	CH 13-14
5	AES Pair 3: +	
6	AES Pair 2: -	CH 11-12
7	AES Pair 4: +	CH 15-16 (HI,VI)
8	AES Pair 4: +	

— Table 3 —

Automation Inputs (RJ45)	
Pin #	Description
1	GPI 1
2	GPI 2
3	GPI 3
4	GPI 4
5	GPI 5
6	GPI 6
7	UNUSED
8	Ground

Front Panel OLED Screens

Design Status

- **Device** – The name of the Core as defined in Q-SYS Designer.
- **Design** – The name of the currently running design.
- **Status** –
 - **OK** – Audio is good, hardware is good.
 - **Compromised** – Audio is good but a redundancy mechanism is active (one LAN down but the other is still up) or a non-fatal hardware problem exists.
 - **Fault** – Audio is not passing, or hardware is malfunctioning or mis-configured
 - **Missing** – A piece of hardware, defined in the design, has not been discovered. Audio is not passing through that piece of hardware.
 - **Initializing** – Starting the firmware, configuration update, and the design. Audio is obviously not available during initialization.
 - **Not Present** – A virtual component in the design, that is designated as Dynamically Paired, and Not Required, has no hardware assigned to it.

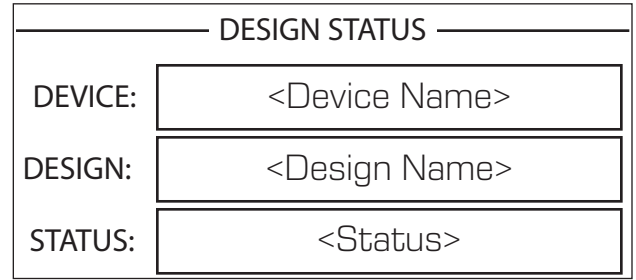

– Figure 9 –

System Status

- **Firmware** – The version number of the firmware currently installed on the DCIO.
- **Temp** – The current chassis temperature of the DCIO.
- **Level** – The current master level setting -100 dB to +20 dB. Adjust with front-panel rotary or in Q-SYS Designer.
- **Mute** – The current master mute status. Controlled by front panel Mute button or in Q-SYS Designer.

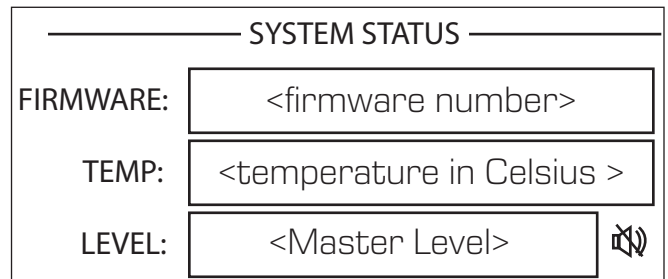

– Figure 10 –

LAN A

You can edit this information in the Q-SYS Configurator.

- **Static, Auto or No Link** – Displays next to LAN A, indicates if the device's IP Address is Static, Automatic, or No Link.
- **IP Address** – The IP Address assigned to the Core's LAN A. LAN A is the primary Q-LAN connection to the Core, and is required.
- **Net Mask** – The Net Mask assigned to the Core.
- **Gateway** – The Gateway assigned to the Core.

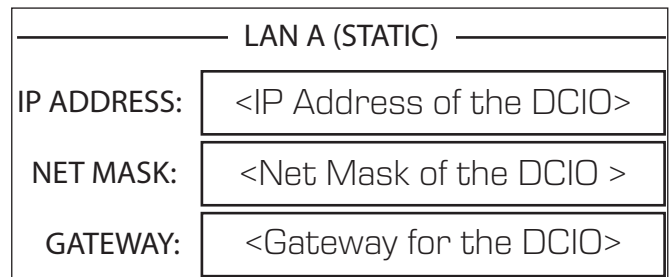

– Figure 11 –

LAN B

LAN B is used for redundancy, and is not required. The information is the same as LAN A.

AES 1–8 and AES 9–16 Channel Status

You must have AES 9–16 Enabled in Q-SYS Designer to see channels 9–16.

- **Mute** – Displays a "muted loudspeaker" when the channel is muted.
- **Signal** – Displays a blinking or solid circle when there is a signal present on the associated channel, an empty circle if there is no signal.

AES 1–8	1	2	3	4	5	6	7	8
Mute								
Signal								

— Figure 12 —

HDMI 1–8 Channel Status

- **Mute** – Displays a "muted loudspeaker" when the channel is muted.
- **Signal** – Displays a blinking or solid circle when there is a signal present on the associated channel, an empty circle if there is no signal, and nothing if that channel doesn't exist in the current stream.
- **Bitstream Type** – Displays the type of bitstream detected at HDMI input.
- **Sample Rate** – Displays the sample rate detected at the HDMI Input.

HDMI	L	R	C	LFE	Ls	Rs	Lb	Rb
Mute								
Signal								
PCM								48kHz

— Figure 13 —

Analog In Channel Status

- **Mute** – Displays a "muted loudspeaker" when the channel is muted.
- **Signal** – Displays a blinking or solid circle when there is a signal present on the associated channel, an empty circle if there is no signal.
- **Clip** – Displays a solid circle when the input signal is clipping.
- **+15V** – Displays a solid circle when phantom power is turned on for the Mic Input.

Analog In	Mic	Left	Right
Mute			
Signal			
Clip			
+15V			

— Figure 14 —

Analog Out Channel Status

- **Mute** – Displays a "muted loudspeaker" when the channel is muted.
- **Signal** – Displays a blinking or solid circle when there is a signal present on the associated channel, an empty circle if there is no signal
- **Clip** – Displays a solid circle when the input signal is clipping.

Analog Out	HI	VI	Line	Amp
Mute				
Signal				
Clip				

— Figure 15 —

Dimensions

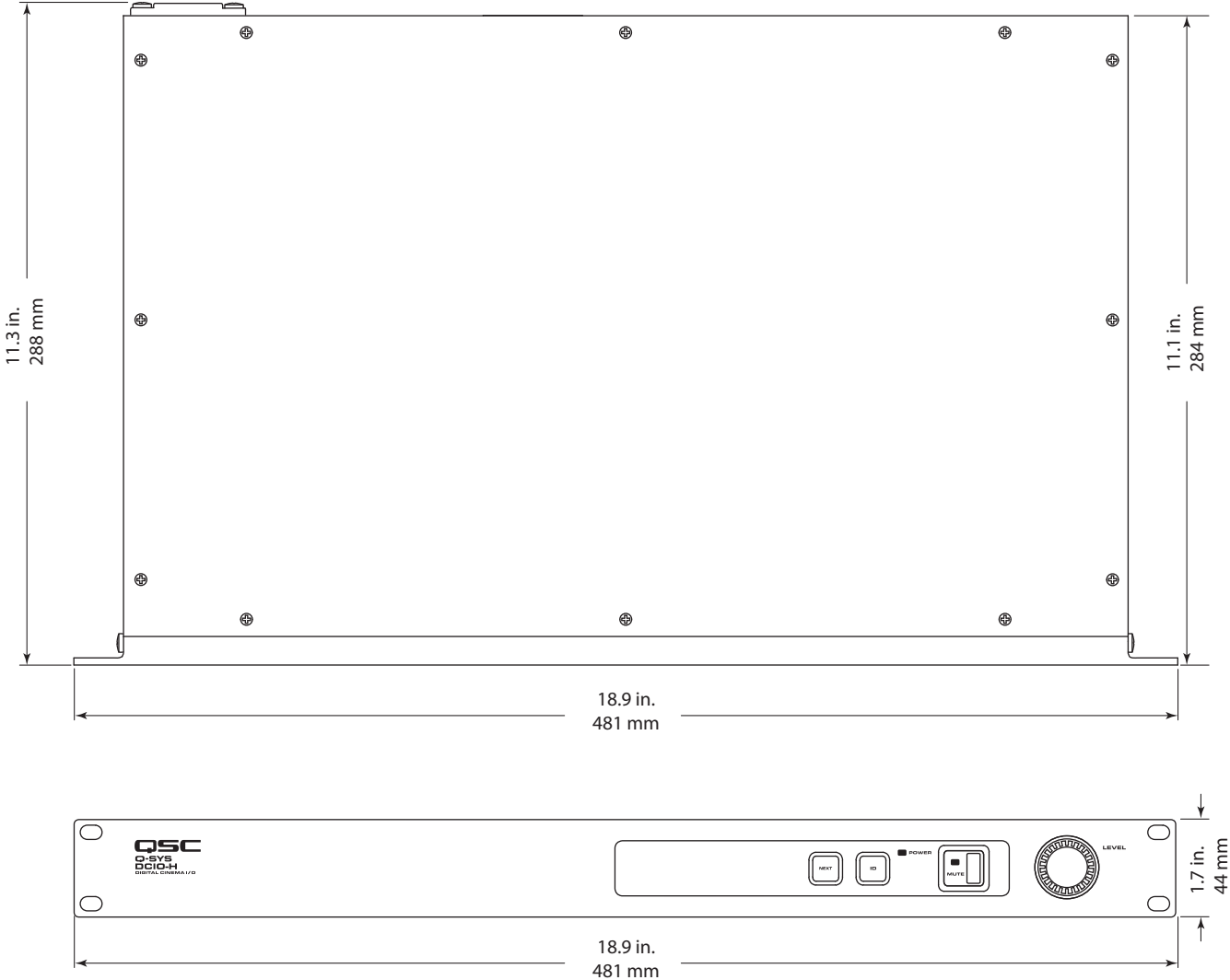

— Figure 16 —

Specifications

Specification	Value
Dimensions (HxWxD)	1.75 (2 RU) x 19 x 11.2 inches (44 x 483 x 282.5 mm)
Line voltage requirements	100 VAC – 240 VAC, 50/60 Hz
Accessories included	1m UL/CSA line cord, Euro-style connectors for outputs and relay connections
Front Panel Controls and Indicators	
Level adjust	Rotary encoder
Power On indicator	Blue LED
Display	Monochrome 304x96 blue OLED graphics display
Other	Momentary mute button Mute LED (red) Screen Navigation (Next) and ID buttons
Rear Panel Connectors	
Mic/Line input	XLR — Mic (+ phantom power) or line level
Line Input	3.5 mm TRS
H.I./V.I. output	5-pin Euro-style (x1) – common GND
Line/Speaker Outputs	Line: 3-pin Euro-style, Speaker: 2-pin Euro-style
Relay outputs	3-pin Euro-style (x4)
AES3/EBU Inputs	Ch. 1–16 (RJ45 x2)
Automation Inputs	RJ45, RS-232
Dual Gigabit Ethernet Q-LAN ports	LAN A, LAN B (RJ45 x2)
HDMI input/output (DCIO-H only)	HDMI 2.0, Type A female connectors
Power switch	Rocker switch
IEC Power Connector	
Audio Performance	
A/D conversion	32-bit delta-sigma, 48 kHz
Frequency response	20 Hz to 20 kHz (+/- .5dB)
AES/EBU Digital Inputs (RJ45)	
Input stage type	Balanced input
Input impedance	110 ohms
Input sample rate	44.1 kHz, 48 kHz or 96 kHz
HDMI Digital Inputs (DCIO-H only)	
Bitstream support	8ch PCM, Dolby Digital Plus™ and DTS-HD®
Input sample rate	44.1 kHz, 48 kHz (Dolby Digital Plus™) All (PCM and DTS-HD®)
Mic/Line Input (XLR)	
Input stage type	Active balanced input
Input impedance	2.2k Ohms
Max analog input level	26 dBu
Dynamic range (unweighted)	> 111 dB
Dynamic range (A-weighted)	> 114 dB
THD+N at 10 dB below clip (26dBu sens)	< 0.02%
THD+N at 10 dB below clip (21dBu sens)	< 0.003%
Input gain	0 to 60dB in 1 dB steps
CMRR typical 2	20 Hz to 20 kHz: > 50dB
EIN	< -122 dB
Phantom power voltage	15V
Stereo Line Inputs	
Connector	3.5mm TRS mini jack
Input stage type	Unbalanced input

Specification	Value
Input impedance (4dBu sens)	> 10k Ohms
Max analog input level (4dBu sens)	15 dBu (4.4 Vrms)
Input impedance (-10dBV sens)	2.7k Ohms
Max analog input level (-10dBV sens)	1 dBV (1.2 Vrms)
Headroom (all sens)	> 10dB
Dynamic range (unweighted)	> 109 dB
Dynamic range (A-weighted)	> 112 dB
THD+N at 2 dB below clip	< 0.003%
HI/VI Outputs	
Connector	5-pin Euro-style with common GND
Output stage type	Balanced output
Max output level	18 dBu (adjustable)
Dynamic range (unweighted)	> 110 dB
THD+N at 2dB below clip	< .009 %
Monitor Output	
Connector	Euro-style
Output stage type	Unbalanced output
Max output level	14 dBu
Dynamic range (unweighted)	> 109 dB
THD+N at 2dB below clip	< .005 %
Powered Monitor Output	
Unbalanced output	Euro-style (2 pins)
Max. Output Power	10 W
Other	
Relay outputs (4)	3-pin Euro-style Normally open (NO), normally closed (NC), and common Max 30 VDC @ 1A
Automation inputs (RJ45 - 6 GPI)	Max input voltage 5V (3.3V typical) TTL compatible dry contact closure
Line voltage	100 VAC to 240 VAC, 50/60 Hz

**Mailing Address:**

QSC, LLC

1675 MacArthur Boulevard

Costa Mesa, CA 92626-1468 U.S.

Main Number: +1.714.754.6175

World Wide Web: www.qsc.com

Sales & Marketing:

Voice: +1.714.957.7100 or toll free (U.S. only) 800.854.4079

FAX: +1.714.754.6174

E-mail: info@qsc.com

Q-SYS™ Customer Support**Application Engineering and Technical Services**

Monday - Friday 7 AM to 5 PM PST (Excludes Holidays)

Tel. 1.800.772.2834 (U.S. only)

Tel. +1.714.957.7150

Q-SYS 24/7 Emergency Support*

Tel: +1.888.252.4836 (U.S./Canada)

Tel: +1.949.791.7722 (non-U.S.)

*Q-SYS 24/7 Support is for Emergency assistance with Q-SYS systems only. 24/7 support guarantees a call back within 30 min after a message is left. Please include, Name, Company, Call Back Number and description of the Q-SYS emergency for prompt call back. If calling during business hours please use the standard support numbers above.

Q-SYS Support Email

qsyssupport@qsc.com

(Immediate email response times not guaranteed)

Cinema Support Email

cinematechsupport@qsc.com

QSC

Technical Services

1675 MacArthur Blvd.

Costa Mesa, CA 92626 U.S.

Tel: 1.800.772.2834 (U.S. only)

Tel: +1.714.957.7150

FAX: +1.714.754.6173

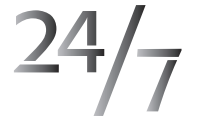

Q-SYS™ Customer Support

© 2015 – 2017 QSC, LLC. All rights reserved. QSC and the QSC logo are registered trademarks of QSC, LLC in the U.S. Patent and Trademark office and other countries. Q-SYS, Q-LAN and, Q-SYS Designer are trademarks of QSC, LLC. Patents may apply or be pending. All other trademarks are the property of their respective owners.

For DTS patents, see <http://patents.dts.com>. Manufactured under license from DTS, Inc. DTS, the Symbol, DTS in combination with the Symbol, the DTS-HD logo, and DTS-HD Master Audio are registered trademarks or trademarks of DTS, Inc. in the United States and/or other countries. © DTS, Inc. All Rights Reserved.

Manufactured under license from Dolby Laboratories. Dolby, Dolby Audio, and the double-D symbol are trademarks of Dolby Laboratories. Confidential unpublished works. Copyright 1992-2015 Dolby Laboratories. All rights reserved.

<http://patents.qsc.com>